



descrição description

- Luminária para aplicação saliente ou suspensa;
- Corpo em perfil de alumínio com acabamento anodizado natural mate;
- Equipada com difusor acrílico opal 030;
- Luminária para uma só lâmpada, constituída por dois perfis sobrepostos;
- Linhas contínuas disponíveis sob consulta;
- Inclui conjunto de acessórios de montagem e lâmpada T5/830.

- Surface or suspended luminaire;
- Natural matt anodised finish aluminium profile housing;
- Fitted with 030 opal acrylic diffuser;
- Single lamp luminaire made of two overlapped profiles;
- Continuous light lines available on request;
- T5/830 lamp and mounting accessory set are included.

Saliente . Surface

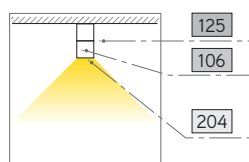

Suspensa . Suspended

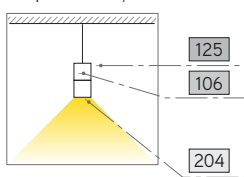

pormenores details



- Inclui conjunto de suspensão e cabo de alimentação com 1 metro (standard) . Suspension set with 1 metre (standard) supply cable included

acabamento finishing

- 106** Cinza alumínio RAL 9006 . RAL 9006 aluminium grey
- 125** Alumínio anodizado natural mate . Natural matt anodised aluminium

diagr.polar p.diagr

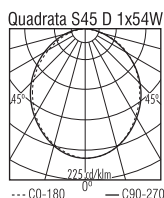

simbologia symbols ·



difusor diffuser · 204 Acrílico opal 030 . *Opal 030 acrylic*

opções options · HF - Balastro Electrónico . *High Frequency Electronic Control Gear*

DIM - Balastro Electrónico com Regulação do Fluxo Luminoso . *With High Frequency Electronic Dimming Control Gear*

DALI (Digital Addressable Lighting Interface) - Com Balastro digital compatível com DALI . *With digital DALI-compatible ballast*

extras standard extras ·

Designação . Name	Cod.
KIT 1H - Módulo Emergência 1 hora . <i>1 hour Emergency</i>	35.00.001.01.16

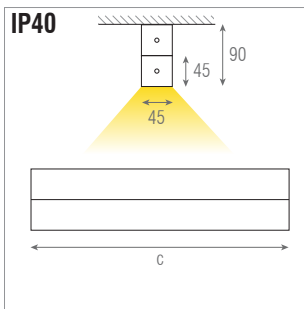

Quadrata S45 D - Saliente . *Surface*



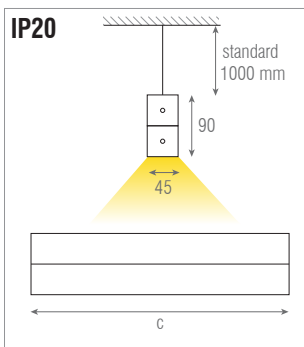









W		(mm) c	kg	(dm ³)	Kit 1H	HF (33.41.32...)	DIM (33.41.32 ...)	DALI (33.41.32 ...)
1x28W	G5	1215	2,8	4,97	•	128000	128002	128003
1x35W	G5	1515	3,5	6,15	•	135000	135002	135003
1x49W	G5	1515	3,5	6,15	•	149001	149003	149004
1x54W	G5	1215	2,8	4,97	•	154000	154002	154003
1x80W	G5	1515	3,5	6,15	•	180000	180002	180003



Quadrata S45 D - Suspensa . *Suspended*

W		(mm) c	kg	(dm ³)	Kit 1H	HF (33.41.32...)	DIM (33.41.32 ...)	DALI (33.41.32 ...)
1x28W	G5	1215	2,8	4,97	•	128001	128004	128005
1x35W	G5	1515	3,5	6,15	•	135001	135004	135005
1x49W	G5	1515	3,5	6,15	•	149000	149005	149006
1x54W	G5	1215	2,8	4,97	•	154001	154004	154005
1x80W	G5	1515	3,5	6,15	•	180001	180004	180005



	Saliente tecto <i>Ceiling surface</i>		Aplique parede <i>Wall surface</i>		Saliente chão <i>Floor surface</i>		De canto <i>Corner mounted</i>
	Encastrado tecto <i>Ceiling recessed</i>		Encastrado parede <i>Wall recessed</i>		Encastrado chão <i>Floor recessed</i>		De pé <i>Floor standing</i>
	Trimless tecto <i>Ceiling trimless</i>		Trimless parede <i>Wall trimless</i>		Suspenso tecto <i>Ceiling suspended</i>		De mesa <i>Table standing</i>



Lâmpada não incluída. *Lamp not included.*



Lâmpada incluída. *Lamp included.*



Marca de conformidade com as Normas Europeias do Comité Europeu de Normalização Electrotécnica (CENELEC), aplicável a todo o material eléctrico certificado pela CERTIF no âmbito do acordo CCA do CENELEC. *Reference symbol of compliance with the European Norms of the European Electrotechnical Standardization Committee (CENELEC) applied to every electrical material certified by CERTIF in accordance with the CCA of the CENELEC.*



ENEC - Marca comum europeia concedida no âmbito do Acordo ENEC, aplicável a todo o tipo de luminárias em conformidade com as normas da série EN 60 598. Marca reconhecida em todos os países subscritores do referido acordo. 04 - Numeração atribuída a Portugal. *ENEC - European common reference symbol granted in accordance with the ENEC Agreement, applicable to every type of luminaire within the Standards of the EN 60 598 series. Reference symbol recognized in all the countries that subscribed the referred agreement. 04 -Number assigned to Portugal.*



Produto projectado e fabricado em conformidade com a directiva comunitária 2004 / 108 / CE relativa à Compatibilidade Electromagnética e com a directiva comunitária 2006 / 95 / CE para equipamentos de Baixa Tensão. *Product designed and manufactured in accordance with the Council Directive 2004 / 108 / CE concerning the Electromagnetic Compatibility and the Council Directive 2006 / 95 / CE for Low-Tension equipment.*



Esta luminária não pode ser coberta com material isolante ou análogo. *Luminaire not suitable for covering with thermally insulating material.*



Fonte luminosa LED. *LED light source.*



Classe I - Isolamento principal e protecção por ligação à terra prevista nas partes metálicas acessíveis. *Class I - All the exposed metal parts are connected to one another and to the protective earth conductor.*

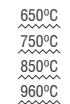

O ensaio é efectuado utilizando um fio de Ni-Cr incandescente aquecido a 650°C, 750°C, 850°C ou 960°C. *The test is made using nickel-chromium flow-wire heated to 650°C, 750°C, 850°C or 960°C.*



Classe II - Com isolamento principal e isolamento suplementar, mas sem meio de protecção por ligação à terra. *Class II - The luminaire is insulated in such a way that there are no exposed metal parts that can carry current. There is no protective earth conductor.*



Luminária protegida contra o arremesso de bolas, de acordo com especificado na norma DIN VDE 0710 part 13/05.81. *Luminaire safe to ball throwing in accordance with DIN VDE 0710 part 13/05.81 standard.*



Classe III - Previsto para alimentação em muita baixa tensão de segurança ($\leq 50V$). *Class III - Appliance designed to be supplied from a safety extra-low voltage power source.*



Dimensão do corte no tecto para encastrar luminária (tolerância em mm). *Cut-out dimension for recessed luminaires (tolerance in mm).*



Casquilho / Suporte de lâmpada. *Lamp holder.*



Adaptável aos módulos standard dos tectos falsos. *Adaptable to the standard modules of the false ceilings.*



Peso unitário aproximado sem embalagem (em Kg). *Unit approximate weight without package (specified in Kg).*



O prefixo IP seguido de dois algarismos, indica a "resistência" oferecida pelo aparelho à penetração de corpos sólidos e líquidos, sendo que o primeiro algarismo identifica a protecção à entrada de elementos sólidos e o segundo aos líquidos. *The IP prefix followed by two figures indicates the "resistance" offered by the device to solid bodies and liquids penetration, the first figure being representative of the protection to solid bodies penetration and the second to liquids.*



Volume unitário com embalagem (em dm³). *Unit approximate volume with package. Specified in dm³.*



Dimensões em mm. *Dimensions in mm.*



Índice Resistência Mecânica - Grau de resistência dos invólucros das luminárias a impactos mecânicos externos, definidos pela norma EN 62262. *Mechanical Resistance Classes - Resistance degree of the luminaires envelope against external mechanical impacts, defined by EN 62262 standards.*



Distância mínima dos objectos iluminados (em metros). *Minimum distance between the lit object and the luminaire (in metres).*