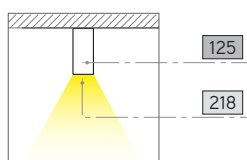

- descrição** description ·
- Luminária de luz directa para aplicação saliente no tecto;
  - Em perfil de alumínio extra-fino com acabamento anodizado natural mate;
  - Versões LED concebidas para aplicação em zonas de transição, corredores, hall de entrada, etc.;
  - Também em versão para lâmpada T5 com vasto leque de dimensões e potências disponíveis;
  - Inclui conjunto de acessórios de fixação.
- Compact dimension set of surface ceiling mounted luminaires;  
 - Extra-slim aluminium profile housing in natural matt anodised finishing;  
 - LED versions suitable for transition areas application such as in corridors and main entrance areas;  
 - T5 lamp versions available in a wide choice of lamp powers and lengths;  
 - Mounting accessory set is include.

**pormenores** details ·

- Perfil de alumínio extra-fino com acabamento anodizado natural mate (33mm x 79mm) . *Extra-slim aluminium profile housing in natural matt anodised finishing (33mm x 79mm)*
- Sistema de clipagem rápida do difusor garante excelente acabamento (acrílico à face com o perfil) e grande facilidade de manutenção da lâmpada . *Quick snap push mount diffuser system ensures excellent finish and easy lamp maintenance*
- Versões LED com fonte de alimentação incluída e LED cor branco quente (Warm White) ou branco frio (Cool White) . *LED versions with integrated power supply in Warm White or Cool White coloured LED*
- Também em versões para lâmpadas T5 e funcionamento com balastos electrónicos . *T5 lamp versions with high frequency electronic ballast also available*

- acabamento** finishing · 125 Alumínio anodizado natural mate . *Natural matt anodised aluminium*

simbologia symbols ·



difusor diffuser · 218 PMMA softpal 050 . PMMA softpal 050

**Snap P3 LED**

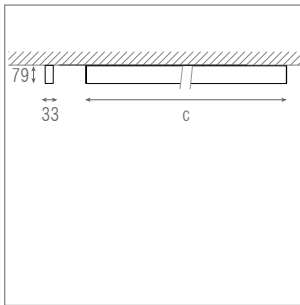

W		lm/W	$\frac{(mm)}{c}$			Cód.
16W Warm White	LED	70	1185	1,6	6	33.41.92.014006
20W Warm White	LED	70	1485	1,9	7,5	33.41.92.018010
16W Cool White	LED	70	1185	1,6	6	33.41.92.014007
20W Cool White	LED	70	1485	1,9	7,5	33.41.92.018011

\*Devido ao método de fabrico dos LED, poderão ser observadas ligeiras diferenças de tonalidade e brilho dentro da mesma gama de cor, com maior realce nas cores branco frio e branco quente . *Due to the LED manufacturing method, slight shade and brightness differences may be noticeable within the same color range particularly in cool white and warm white colors.*

\*\*Para comprimento superior a 1200mm é aconselhável a utilização de fontes externas ou uma linha de tensão reduzida . *Lengths exceeding 1200mm require the use of external power supply or reduced tension line.*



**Snap P3 T5**

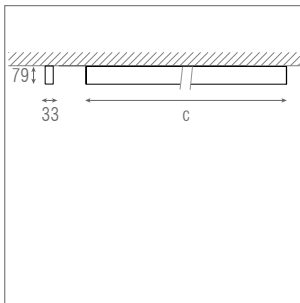

W		$\frac{(mm)}{c}$			HF	DIM	
1x28W	G5	1200	1,7	4,3	33.41.92.128003	33.41.92.128010	33.41.92.128011
1x35W	G5	1500	2,0	5,4	33.41.92.135003	33.41.92.135010	33.41.92.135011
1x49W	G5	1500	2,0	5,4	33.41.92.149004	33.41.92.149010	33.41.92.149011
1x54W	G5	1200	1,7	4,3	33.41.92.154004	33.41.92.154010	33.41.92.154011
1x80W	G5	1500	2,0	5,4	33.41.92.180004	33.41.92.180010	33.41.92.180011

Versões para lâmpadas T5 e funcionamento com balastro electrónico alta-frequência, resultando em excelente rendimento luminoso e baixo consumo energético. Lâmpada não incluída . *T5 lamp versions with high frequency electronic ballast, resulting in excellent lumen package and low energy consumption. Lamp not included.*

**HF** - Versão-base Balastro Electrónico . *Basic-version for luminaires equipped with High Frequency Electronic Control Gear.*

**DIM** - Balastro Electrónico com Regulação Fluxo Luminoso . *High Frequency Dimming Control Gear.*

**Dali** - (Digital Addressable Lighting Interface) - Com Balastro digital compatível com Dali . *With digital Dali-compatible ballast.*

instalação installation ·

**Snap P3 LED - Distância entre centros . Installation hole centre**

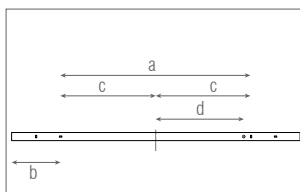

W	a	b	$\frac{(mm)}{c}$	d
16W	780	200	390	360
20W	980	250	490	400



**Snap P3 T5** - Distância entre centros . *Installation hole centre*

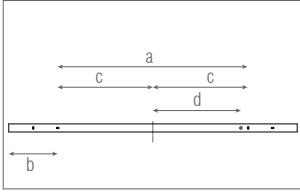





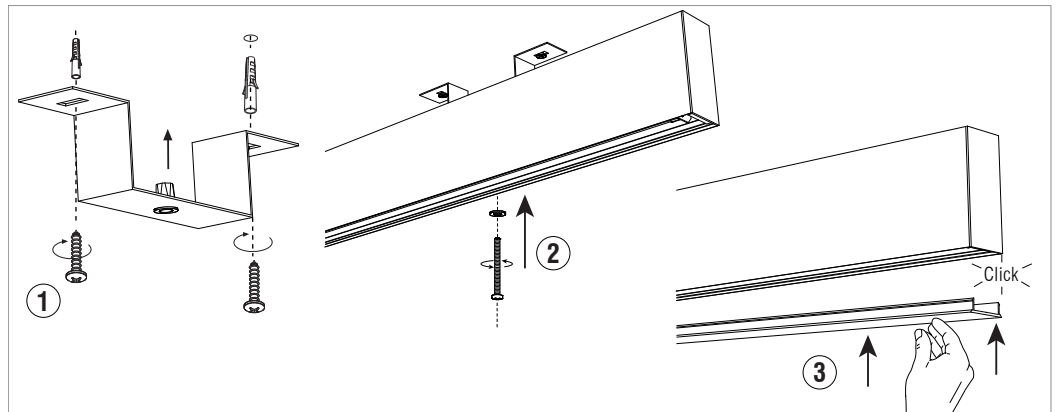



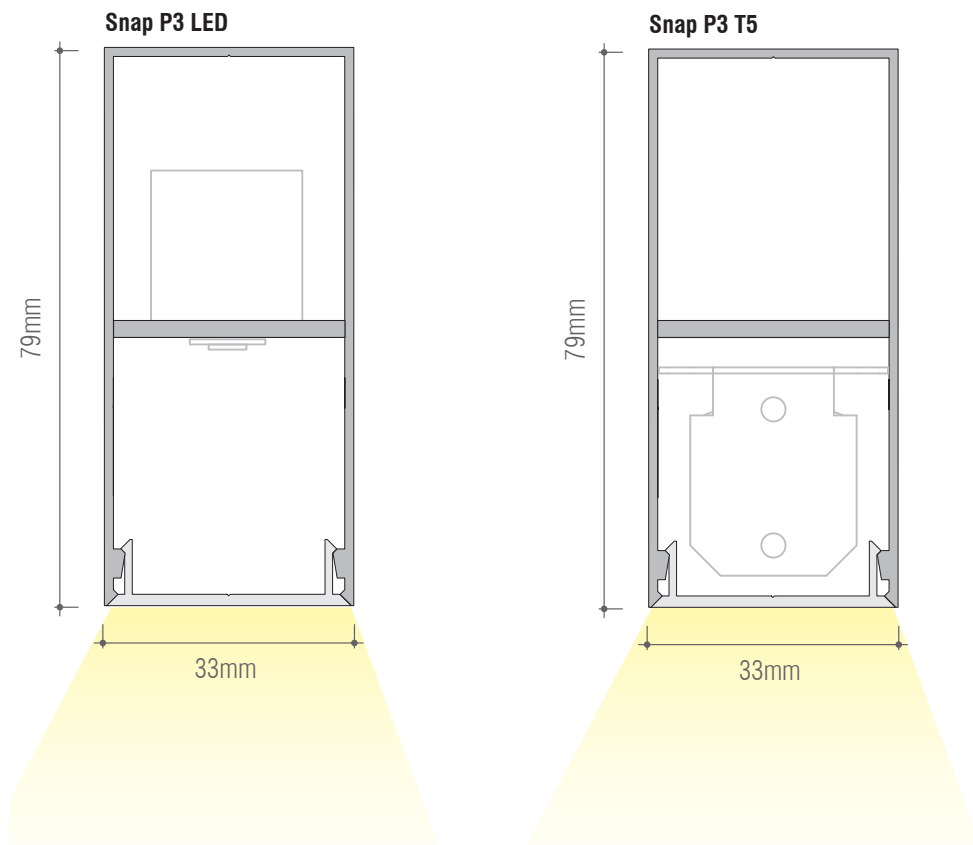















W	(mm)			
	a	b	c	d
1x28W	780	200	390	360
1x35W	980	250	490	400
1x49W	980	250	490	400
1x54W	780	200	390	360
1x80W	980	250	490	400

- Consulte o manual de instruções (DVT.199.11.R) antes de proceder à instalação . *Please refer to the user's manual (DVT.199.11.R) before product installation*



escala 1:1 scale



	Saliente tecto <i>Ceiling mounted</i>		Aplique parede <i>Wall mounted</i>		Encastrada chão <i>Floor recessed</i>		De canto <i>Corner mounted</i>
	Suspensa <i>Suspended</i>		Encastrada parede <i>Wall recessed</i>		Encastrada tecto <i>Ceiling recessed</i>		De pé <i>Floor standing</i>
	Lâmpada não incluída. <i>Lamp not included.</i>				Lâmpada incluída. <i>Lamp included.</i>		De mesa <i>Table Standing</i>
	Marca de conformidade com as Normas Europeias do Comité Europeu de Normalização Electrotécnica (CENELEC), aplicável a todo o material eléctrico certificado pela CERTIF no âmbito do acordo CCA do CENELEC. <i>Reference symbol of compliance with the European Norms of the European Electrotechnical Standardization Committee (CENELEC) applied to every electrical material certified by CERTIF in accordance with the CCA of the CENELEC.</i>				ENEC - Marca comum europeia concedida no âmbito do Acordo ENEC, aplicável a todo o tipo de luminárias em conformidade com as normas da série EN 60 598. Marca reconhecida em todos os países subscritores do referido acordo. 04 - Numeração atribuída a Portugal. <i>ENEC - European common reference symbol granted in accordance with the ENEC Agreement, applicable to every type of luminaire within the Standards of the EN 60 598 series. Reference symbol recognized in all the countries that subscribed the referred agreement. 04 -Number assigned to Portugal.</i>		
	Produto projectado e fabricado em conformidade com a directiva comunitária 2004 / 108 / CE relativa à Compatibilidade Electromagnética e com a directiva comunitária 2006 / 95 / CE para equipamentos de Baixa Tensão. <i>Product designed and manufactured in accordance with the Council Directive 2004 / 108 / CE concerning the Electromagnetic Compatibility and the Council Directive 2006 / 95 / CE for Low-Tension equipment.</i>				Esta luminária não pode ser coberta com material isolante ou análogo. <i>Luminaire not suitable for covering with thermally insulating material.</i>		
	<b>Classe I</b> - Isolamento principal e protecção por ligação à terra prevista nas partes metálicas acessíveis. <i>Class I - All the exposed metal parts are connected to one another and to the protective earth conductor.</i>				Fonte luminosa LED. <i>LED light source.</i>		
	<b>Classe II</b> - Com isolamento principal e isolamento suplementar, mas sem meio de protecção por ligação à terra. <i>Class II - The luminaire is insulated in such a way that there are no exposed metal parts that can carry current. There is no protective earth conductor.</i>				O ensaio é efectuado utilizando um fio de Ni-Cr incandescente aquecido a 650°C, 750°C, 850°C ou 960°C. <i>The test is made using nickel-chromium flow-wire heated to 650°C, 750°C, 850°C or 960°C.</i>		
	<b>Classe III</b> - Previsto para alimentação em muita baixa tensão de segurança ( $\leq 50V$ ). <i>Class III - Appliance designed to be supplied from a safety extra-low voltage power source.</i>				Luminária protegida contra o arremesso de bolas, de acordo com especificado na norma DIN VDE 0710 part 13/05.81. <i>Luminaire safe to ball throwing in accordance with DIN VDE 0710 part 13/05.81 standard.</i>		
	Casquilho / Suporte de lâmpada. <i>Lamp holder.</i>				Dimensão do corte no tecto para encastrar luminária (tolerância em mm). <i>Cut-out dimension for recessed luminaires (tolerance in mm).</i>		
	Peso unitário aproximado sem embalagem (em Kg). <i>Unit approximate weight without package (specified in Kg).</i>				Adaptável aos módulos standard dos tectos falsos. <i>Adaptable to the standard modules of the false ceilings.</i>		
	Volume unitário com embalagem (em dm <sup>3</sup> ). <i>Unit approximate volume with package. Specified in dm<sup>3</sup>.</i>				O prefixo IP seguido de dois algarismos, indica a "resistência" oferecida pelo aparelho à penetração de corpos sólidos e líquidos, sendo que o primeiro algarismo identifica a protecção à entrada de elementos sólidos e o segundo aos líquidos. <i>The IP prefix followed by two figures indicates the "resistance" offered by the device to solid bodies and liquids penetration, the first figure being representative of the protection to solid bodies penetration and the second to liquids.</i>		
	Dimensões em mm. <i>Dimensions in mm.</i>				Índice Resistência Mecânica - Grau de resistência dos invólucros das luminárias a impactos mecânicos externos, definidos pela norma EN 50102. <i>Mechanical Resistance Classes - Resistance degree of the luminaires envelope against external mechanical impacts, defined by EN 50102 standards.</i>		
	Distância mínima dos objectos iluminados (em metros). <i>Minimum distance between the lit object and the luminaire (in metres).</i>						